



**KOMA PRECISION**  
THE KEY TO PERFORMANCE  
[www.komaprecision.com](http://www.komaprecision.com)

# Alberti

## ANGLE HEAD

### Selection Guide



**WE FOCUS ON BEING THE BEST—**  
that's why leading companies choose Koma.

WE ARE THE EXCLUSIVE NORTH AMERICAN  
IMPORTER, NATIONAL DISTRIBUTOR, AND  
SERVICE CENTER FOR ALBERTI ANGLE HEADS.

**SLIMLINE**



## KOMA PRECISION

---

For over forty years Koma Precision has been the foremost source for the finest the world has to offer in machine tool Productivity Innovation.

With over 30,000 rotary table installations, Koma is the largest distributor of Tsudakoma NC rotary tables and indexers in the world. With over 12,000 angle heads and live tools installed, Koma is the world's largest supplier for Alberti - the originator and the foremost innovator of productivity tooling.



## DIMENSIONAL DRAWING

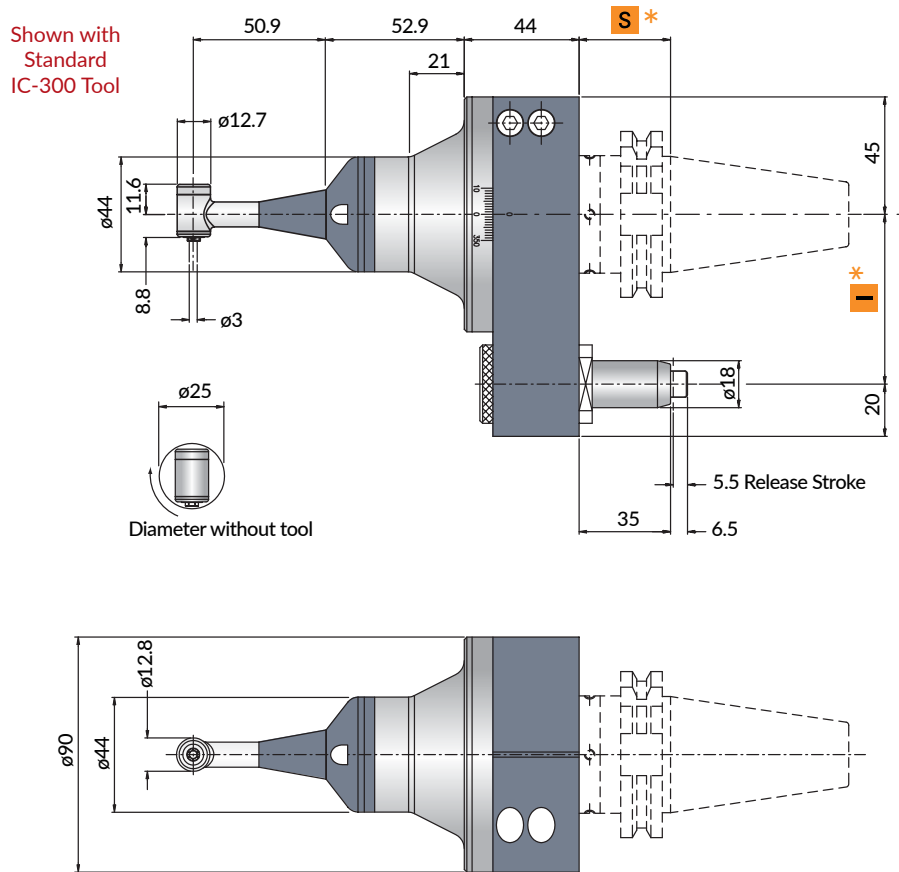

### Optional Drive Shanks\*

Non interchangeable input drive shank

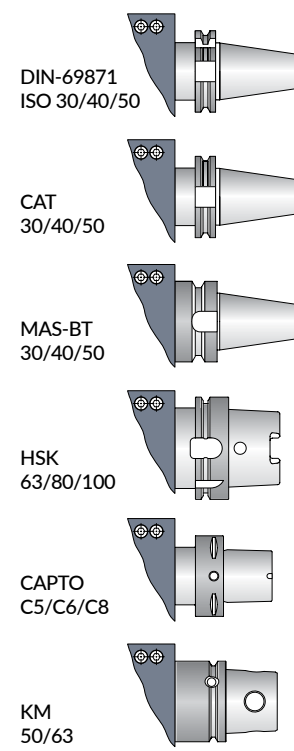

## DIMENSIONAL DRAWING & OPTIONAL DRIVE SHANKS

## TECHNICAL DATA

SHANK	DIN-69871 / CAT			MAS / BT			HSK		CAPTO		KM
Size	30	40	50	30	40	50	63/80	100	C5/C6	C8	50/63
I Arm Length (mm)	65,80	65,80 (110*)	80 (110*)	65,80	65,80 (110*)	80 (110*)	65,80 (110*)	80 (110*)	65,80 (110*)	80 (110*)	65,80 (110*)
S Flange Spacing (mm)	35	35	35	30	35	41	42	45	38	40	40

T90sl-0.3 - with IC-300	
Ratio	1:75
Maximum Input RPM	15,000
Maximum Output RPM	11,250
Weight	7.7 lbs

Included with Tool:  
Storage Case • Wrenches • Instruction Manual

## DIMENSIONAL DRAWING

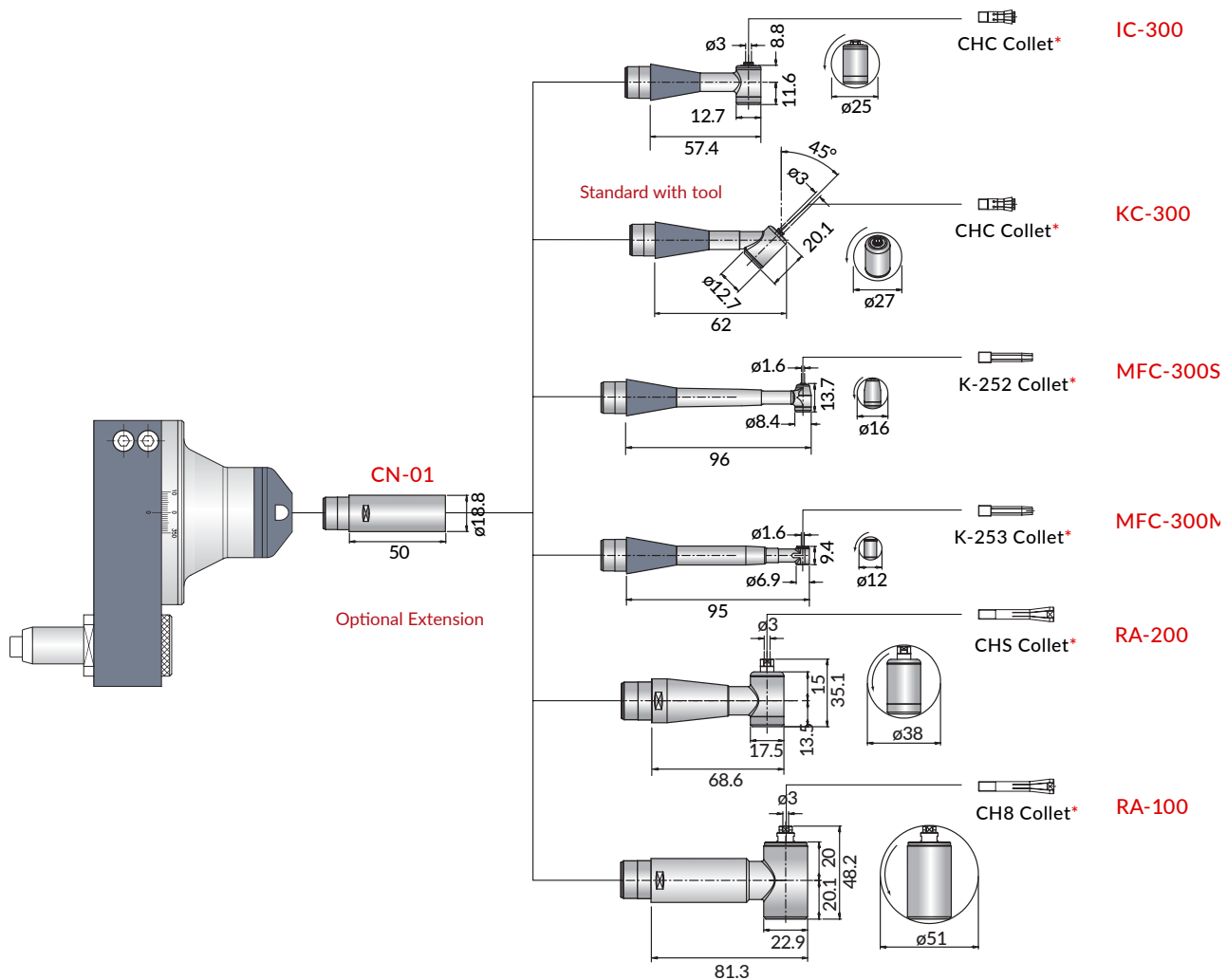

## TECHNICAL DATA

	IC-300	KC-300	MFC-300S	MFC-300M	RA-200	RA-100	CN-01
<b>Ratio</b>	1:75	1:75	1:1	1:1	1:66	1:375	1:1
<b>Max. NSK Output RPM</b>	11,250	11,250	15,000	15,000	10,000	5,620	15,000
<b>Torque</b>	.74 ft lbs	.74 ft lbs	.74 ft lbs	.74 ft lbs	2.95 ft lbs	2.95 ft lbs	-
<b>NSK Collet</b>	CHC	CHC	K-252	K-253	CHS	CH8	-

Included with Tool: Storage Case • (1) NSK Tool • Wrenches • Instruction Manual

## CHC (for IC-300, KC-300)



Model	Inside Diameter (mm)
GP-59021-00	1.6
GP-59024-00	2.35
GP-59015-00	3.0
GP-59010-00	3.175

## CHS (for RA-200)

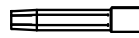

Model	Inside Diameter (mm)
GP-59027-00	0.8
GP-59028-00	0.9
GP-59029-00	1.0
GP-59030-00	1.1
GP-59031-00	1.2
GP-59032-00	1.3
GP-59033-00	1.4
GP-59034-00	1.5
GP-59012-00	1.6
GP-59035-00	1.7
GP-59036-00	1.8
GP-59037-00	1.9
GP-59016-00	2.0
GP-59038-00	2.1
GP-59039-00	2.2
GP-59040-00	2.3
GP-59041-00	2.35
GP-59042-00	2.4
GP-59013-00	2.5
GP-59043-00	2.6
GP-59044-00	2.7
GP-59045-00	2.8
GP-59046-00	2.9
GP-59009-00	3.0
GP-59011-00	3.175

## CH8 (for RA-100)

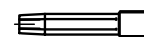

Model	Inside Diameter (mm)
GP-59047-00	0.8
GP-59048-00	0.9
GP-59049-00	1.0
GP-59050-00	1.1
GP-59051-00	1.2
GP-59052-00	1.3
GP-59053-00	1.4
GP-59054-00	1.5
GP-59055-00	1.6
GP-59056-00	1.7
GP-59057-00	1.8
GP-59058-00	1.9
GP-59059-00	2.0
GP-59060-00	2.1
GP-59061-00	2.2
GP-59062-00	2.3
GP-59063-00	2.35
GP-59064-00	2.4
GP-59065-00	2.5
GP-59066-00	2.6
GP-59067-00	2.7
GP-59068-00	2.8
GP-59069-00	2.9
GP-59070-00	3.0
GP-59008-00	3.175

## K-252 (for MFC-300S)

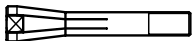

Model	Inside Diameter (mm)
GP-59025-00	1.6

## K-253 (for MFC-300M)

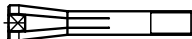

Model	Inside Diameter (mm)
GP-59026-00	1.6

## OPTIONAL STOP BLOCK

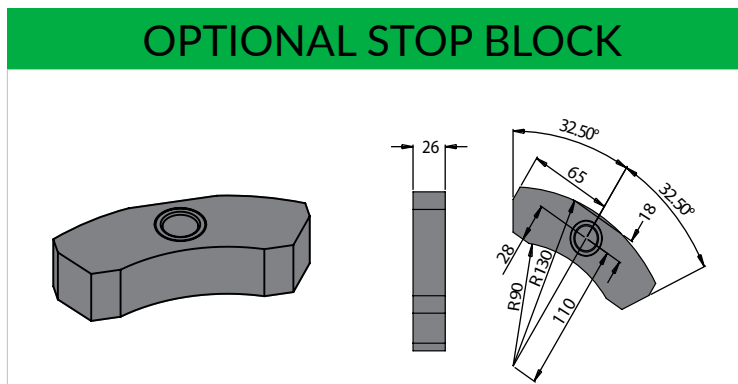



# UNLOCK YOUR POTENTIAL TODAY!

For Over 40 years Koma Precision Inc. has partnered with Tsudakoma and Alberti, to become the North American leader in machine tool accessories. Both Tsudakoma and Alberti machine tool accessories are built to the highest standards and set the bar for excellence, quality, and performance.

Koma Precision has an installation base of over 30,000 Tsudakoma rotary tables and 25,000 Alberti angle heads and live tools, leading the way with knowledge and experience.

## Knowledge and Experience Matter.

Our three facilities totaling 40,000 sq/ft, feature a full machine shop, state-of-the-art inspection and test equipment, and product demonstration showroom. Our Connecticut based headquarters also houses our multi-million-dollar inventory of new products and spare parts.



20 Thompson Road  
East Windsor, CT 06088

Tel: 1.800.249.5662  
Fax: 860.623.4132  
info@komaprecision.com



**KOMA PRECISION**  
[www.komaprecision.com](http://www.komaprecision.com)

